

SIEMENS



Siemens Aktiengesellschaft,
issued by Siemens Communications
Haidenauplatz 1
D-81667 Munich

© Siemens AG 2005
All rights reserved. Subject to availability.
Rights of modification reserved.

Siemens Aktiengesellschaft
www.siemens.com/gigaset

Gigaset SX255isdn/SX205isdn

CORDLESS HOME COMMUNICATION **Gigaset**

Overview of the base station

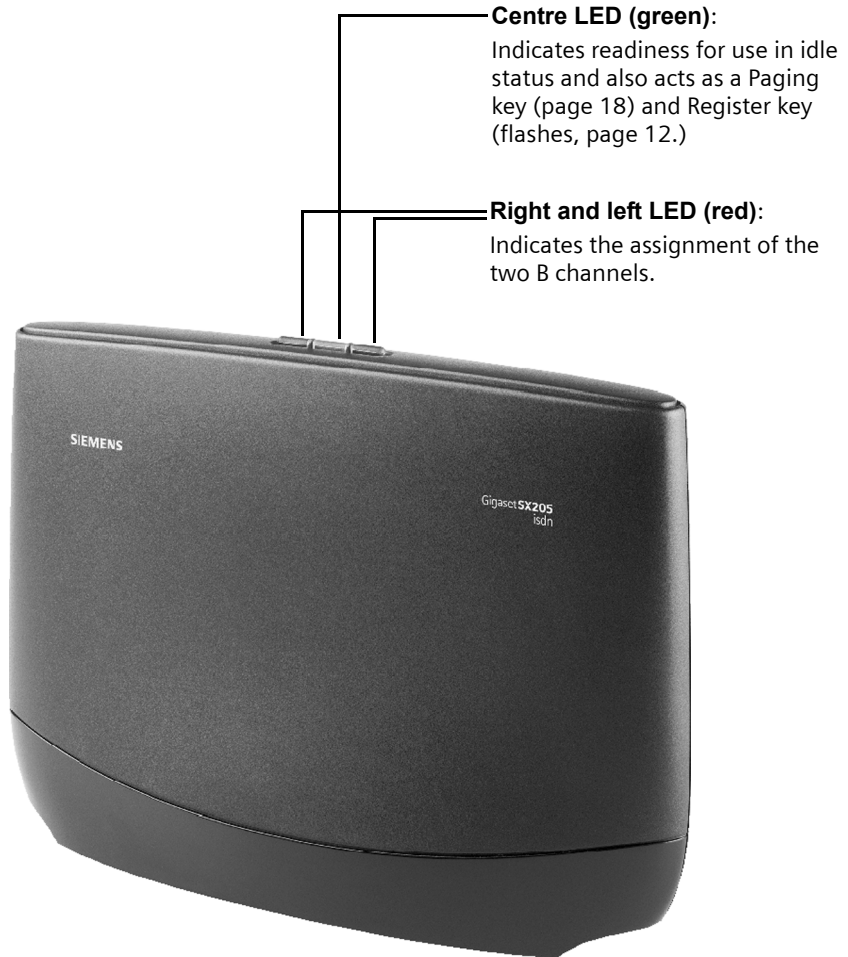

Contents

- Overview of the base station 1**
- Safety precautions 4**
- Getting started 5**
 - Pack contents 5
 - Notes on installation 5
 - Use as desktop unit 6
 - Mounting the base as a wall unit 6
 - Connecting the base 7
 - Connecting auxiliary equipment 8
 - Setting and operating the base 9
 - Registering handsets 12
 - De-registering handsets 18
 - Locating a handset (paging) 18
- The quick way into the world of ISDN 19**
- Answering machine 20**
 - Operation using a registered handset 20
 - Remote control of answering machines 22
- Connecting devices 26**
 - Connecting cord-based analogue devices 26
 - Making calls with devices on the analogue connection (TAE connection) 29
 - Defining the device type 30
 - Connecting PC via USB 31
 - Gigaset Repeater 31
- Operation of entrance telephone 32**
 - Connecting entrance telephones 32
- Appendix 34**
 - Care 34
 - Contact with liquid 34
 - Questions and Answers 34
 - Service (Customer Care) 35
 - Specifications 37
- Accessories 38**

ISDN glossary	41
Index	49

Safety precautions



- ◆ Read the safety precautions and the operating instructions before use.
- ◆ Explain their contents to your children, and the potential hazards associated with using the telephone.



Use **only the power unit supplied**, as indicated on the underside of the base station.



The operation of medical appliances may be affected. Be aware of the technical conditions within the particular environment (e. g. doctor's practice).



Do not install the base in bathrooms or shower rooms (see page 7 and page 34). The handset and base are not watertight.



Do not use the phone in environments subject to explosion hazard (e. g. auto paint shops).



If you give your Gigaset to someone else, make sure you also give them the operating instructions.



Please dispose of the telephone in an environmentally friendly manner.



- ◆ Please note that only terminals that are operated inhouse (inside buildings) may be connected to the analogue TAE connections.
- ◆ Not all of the functions described in these operating instructions are available in all countries.

Getting started

Pack contents

- ◆ 1 base
- ◆ 1 power supply cord with power unit
- ◆ 1 ISDN connection cable
- ◆ 1 USB cable
- ◆ 1 wall holder
- ◆ Operating instructions

Notes on installation

- ◆ The installation location must have a 220/230V~ mains outlet and an ISDN telephone connection.
- ◆ For optimum radio reception, you should install the base at a central point wherever possible.
- ◆ The installation location should not be in the immediate vicinity of other equipment, e. g. hi-fi, television, office or microwave equipment, in order to prevent mutual interference. Minimum distance (including to base power unit): 1.5 metres.
In case of picture and sound interference on satellite reception equipment, please contact your retailer to have your satellite reception system checked for a lack of screening.
- ◆ Avoid direct contact with sources of heat (e .g. radiators).
- ◆ Do not expose the base to direct sunlight.
- ◆ The base can also be wall mounted, using the wall holder included in the pack.
- ◆ If you are not using wall mounting, install the base on a level, non-slip surface. The feet of the device do not normally leave any marks on the installation surface. However, in view of the variety of paints and polishes available, it cannot be ruled out, that contact may cause marks on the installation surface.
- ◆ The range between the base and the handsets is up to 300 m in the open air. Inside buildings, ranges of up to 50 m can be achieved.

Getting started

Use as desktop unit

Your telephone can be used as a space-saving desktop unit. Before connecting the base, please read the notes on installation (page 4, page 5).

Mounting the base as a wall unit

Before mounting the base, please read the notes on installation (page 4, page 5).

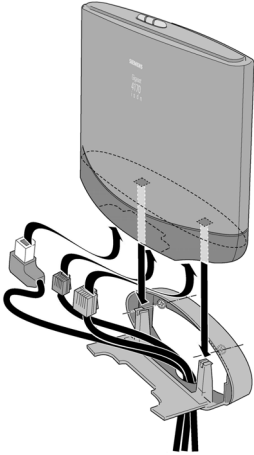

1. Drill two holes (\varnothing 5 mm) 80 mm apart next to one another in the wall.
2. Use appropriate rawlplugs.
3. Screw in two round screws (\varnothing 4 mm).
4. Before attaching the wall holder and tightening the screws, place the connection cable through the holder from the back to the front. Ensure that the connection cable lies freely in the back recess.
5. Now plug the connection cable into the base (see Connecting the base).
6. Using slight vertical pressure from the top centre, press the base onto the retaining catches on the wall holder.

Connecting the base

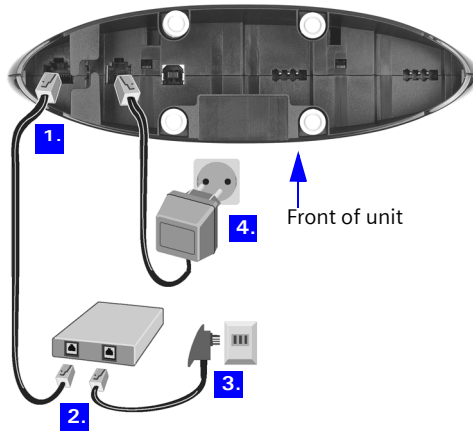

Schematic illustration

1. -S₀ jack: Insert ISDN connection cable until connector clicks into place.
2. Insert ISDN connection cable into ISDN connection until connector clicks into place.
3. For NTBA with self-mounting, plug in the cable between the NTBA and the TAE (old telephone outlet) or Mini-Western connector until both connectors click into place.
4. jack: Plug in the power supply cord, until the connector clicks into place and plug into the mains outlet.

!	Use only the power unit supplied , as indicated on the underside of the base station.
----------	--

i	<p>Power failure:</p> <p>Your base and the handsets registered on it, as well as wire-based terminals cannot operate in case of power failure. However, all the settings and stored information (messages, phonebook entries etc.) are retained indefinitely.</p>
----------	---

Connecting auxiliary equipment

You can connect the following auxiliary equipment to your base:

- ◆ up to eight wireless devices (handsets see page 12, Gigaset data modules see page 31, Gigaset Repeater see page 31)
- ◆ up to two analogue, wire-based devices (e. g. telephone, answering machine, fax machine, entrance telephone – see page 26)
- ◆ a PC via USB port (USB V1.1 – see page 31)

Insert the USB cable into the base station, but **do not connect it to the PC yet**. Only attach the USB cable to the PC when prompted to do so by the PC program **talk&surf wizard**.

Connection in Germany

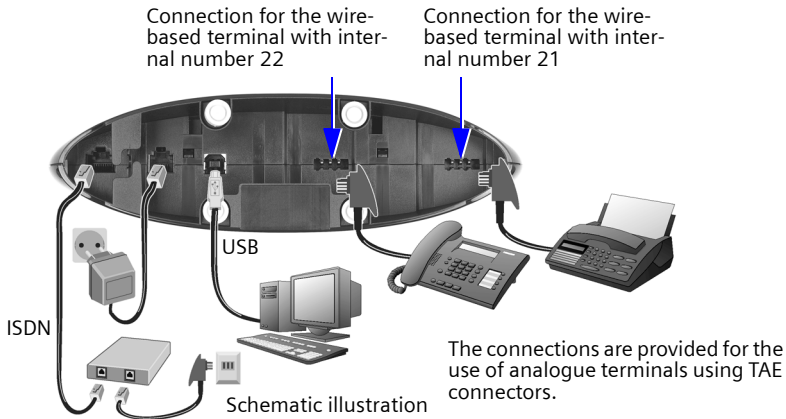

Connection in other countries

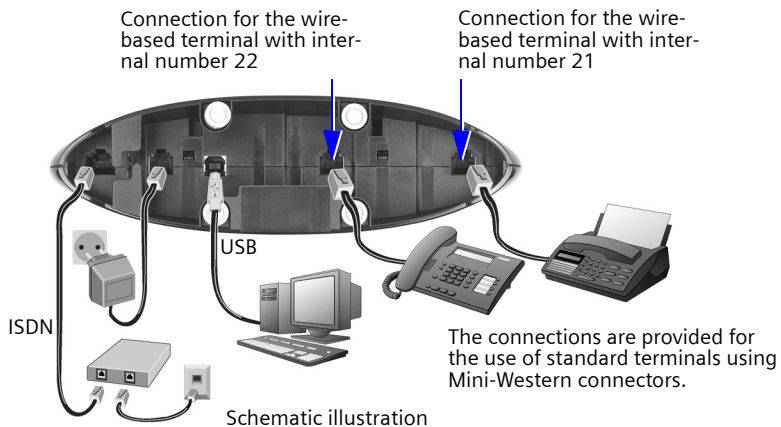

Setting and operating the base

Preparing the base for use and making settings

In order to be able to use your base, certain settings are required, e. g. the ISDN phone number (MSN). To do this, you need a handset or a PC. More details can be found in the operating instructions for your handset or your PC software.

If you have an S44, S1 or SL1 added-feature handset, a Getting started wizard is available to assist you in making the settings. More details can be found in the operating instructions for your added-feature handset.

Operating the base from a handset



Operating instructions are enclosed for the S44 handset. You will find operating instructions for other handsets on the enclosed CD-ROM or on the Internet at www.siemens.com/gigaset.

Using "**Assigning an MSN a ringer melody**" as an example, you are shown below how to operate the base station with the following handsets:





















- ◆ S44,
- ◆ S1 and SL1,
- ◆ C34,
- ◆ C1, C2 and C32.

You will find the meaning of the symbols used and information about operating your handset in the relevant operating instructions.

Operating the base from an S44 handset



The central operator control on the S44 handset is a control key  which has four direction arrows with the associated symbols. Pressing the various icons (up, down, right, or left) opens a different function. The side you have to press is shown by a black triangle in the operating instructions, e. g.:  key for right = open menu.

Example: "Assigning an MSN a ringer melody"











		Open the menu.
 		Select the menu item and confirm.
 Base		Select the menu item and confirm.
 Settings		Select the menu item and confirm.
  		If necessary, enter the system PIN of the base (the default is 0000) and confirm.
 ISDN settings		Select the menu item and confirm.
 Set up MSN		Select the menu item and confirm.
 MSN1:		Select MSN, e. g. MSN1: Anna.
		Open the submenu.
 Ringer melody		Select the menu item and confirm.
 Ringer melody: 5		Select melody (1 – 10, Device ringer) and confirm, e. g. Ringer melody: 5.

Getting started



Operating the base from an S1 or SL1 handset

The central operator control on the S1 and SL1 handsets is a control key , which has four black direction arrows with the associated symbols. Pressing the various icons (up, down, right, or left) opens a different function. The side you have to press is shown by a black triangle in the operating instructions, e. g.:  key for right = open menu.











Example: "Assigning an MSN a ringer melody"

		Open the menu.
 Set base	OK	Select the menu item and confirm.
 Settings	OK	Select the menu item and confirm.
 OK		If necessary, enter the system PIN of the base (the default is 0000) and confirm.
 ISDN settings	OK	Select the menu item and confirm.
 Set up MSN	OK	Select the menu item and confirm.
 MSN1:		Select MSN, e. g. MSN1: Anna.
		Open the submenu.
 Ringer Melody:	OK	Select the menu item and confirm.
 Ringer Melody: 5	OK	Select melody and confirm, e. g. Ringer Melody: 5.

Operating the base from a C34 handset



The central operator control on the C34 handset is a control key  which, among other things, has a triangle on the top and bottom and a spot on the left and right. Pressing the various icons (up, down, right, or left) opens a different function. The side you have to press is shown by a black triangle in the operating instructions. Example:  for "press the top of the control key".



Example: "Assigning an MSN a ringer melody".

		Open the menu.
 Settings	OK	Select the menu item and confirm.
 Base	OK	Select the menu item and confirm.
 Settings	OK	Select the menu item and confirm.
 OK		If necessary, enter the system PIN of the base (the default is 0000) and confirm.
 ISDN settings	OK	Select the menu item and confirm.
 Set up MSN	OK	Select the menu item and confirm.
 MSN1:		Select MSN, e. g. MSN1: Anna.
		Open the submenu.
 Ringer melody	OK	Select the menu item and confirm.
 Ringer melody: 5	OK	Select melody and confirm, e. g. Ringer melody: 5.









Operating the base from a C1, C2 or C32 handset

The **C1**, **C2** and **C32** handsets each have a rocker key, which has two functions.

On the Gigaset C1, the upper half of the rocker key has the function of the Talk key , the lower half the Phonebook key .

On the Gigaset C2 and C32, the upper half of the rocker key has the function of the Talk key , the lower half the Handsfree key .

Example: "Assigning an MSN a ringer melody"

MENU		Open the menu.
 Set base	OK	Select the menu item and confirm.
 Settings	OK	Select the menu item and confirm.
 OK		If necessary, enter the system PIN of the base (the default is 0000) and confirm.
 ISDN settings	OK	Select the menu item and confirm.
 Set up MSN	OK	Select the menu item and confirm.
 MSN1:		Select MSN, e. g. MSN1: Anna .
MENU		Open the submenu.
 Ringer melody: 5	OK	Select melody and confirm, e. g. Ringer melody: 5 ( = set).
 MSN1:		Select MSN, e. g. MSN1: Anna .

Registering handsets

You can register a maximum of eight wireless devices on your base (including Gigaset data modules (page 31) and Gigaset Repeater (page 31)). The internal numbers 11-18 are set aside for this purpose. Wire-based analogue devices do not have to be registered (page 26).

If the internal numbers **Int.11** to **Int.18** on your telephone have already been assigned, please de-register another handset you no longer require before registering a new one (see handset operating instructions).

If necessary, keep the handset operating instructions to hand with their description of the registration process.

You must initiate handset registration on the handset and on the base.

1. On the base

Press the Register/Paging key on the base for about 3 seconds. This starts the registration. The base is ready for registering for 60 seconds.

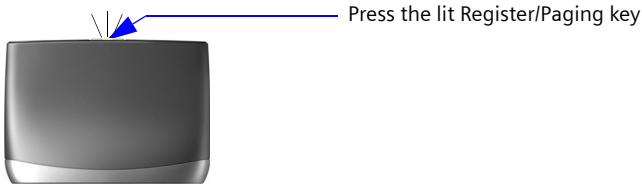















2. On the handset (within 30 sec.)

Register your handset (see handset operating instructions).















If the handset cancels base paging, e. g. because the registration time has been exceeded, repeat the process.

Manually registering a Gigaset S44 handset

		Open the menu.
		Select the menu item and confirm.
	Handset 	Select the menu item and confirm.
	Register H/Set 	Select the menu item and confirm.
	Base 1 	Select base (1–4) and confirm, e. g. Base 1 .
		Enter the system PIN of the base (the default is 0000) and confirm. The display shows Regstr.Procedure and the name of the base flashes, e. g. Base 1 .
		Press lit Register key on the base for approx. 4 seconds (page 12); the key flashes. The base is ready for registering only when the key is flashing.
	INT11: Int.11 	Select internal number and confirm, e. g. INT11: Int.11 .

After registration the handset reverts to idle status. The handset's internal number is shown in the display, e. g. **Int.11**.







Manually registering a Gigaset S1 / SL1 handset

		Open the menu.
	Settings 	Select the menu item and confirm.
	Register H/Set 	Select the menu item and confirm.
	Base 	Select base (1–4) and confirm, e. g. Base 1 .
		Enter the system PIN of the base (factory setting: 0000) and confirm. The display shows Regstr.Procedure and the name of the base flashes, e. g. Base 1 .
		Press lit Register key on the base for approx. 4 seconds (page 12); the key flashes. The base is only ready for registering while the key is flashing.
	INT11: Int.11 	Select internal number and confirm, e. g. INT11: Int.11 .

After registration the handset reverts to idle status. The handset's internal number is shown in the display, e. g. **Int.11**.







Getting started

Manually registering a C34 handset

		Open the menu.
 Handset Settings	OK	Select the menu item and confirm.
 Handset	OK	Select the menu item and confirm.
 Register Handset	OK	Select the menu item and confirm.
 OK		Enter the system PIN of the base (the default is 0000) and confirm. The display shows Regstr.Procedure and the name of the base flashes, e. g. Base 1 .
		Press lit Register key on the base for approx. 4 seconds (page 12); the key flashes. The base is ready for registering only when the key is flashing.
 INT11: Int.11	OK	Select internal number and confirm, e. g. INT11: Int.11 .







After registration the handset reverts to idle status. The handset's internal number is shown in the display, e. g. **Int.11**.

Manually registering a Gigaset C1 / C2 / C32 handset

MENU		Open the menu.
 Handset Settings	OK	Select the menu item and confirm.
 Register Handset	OK	Select the menu item and confirm.
 Base 1	OK	Select base (1–4) and confirm, e. g. Base 1 .
 OK		Enter the system PIN of the base (factory setting: 0000) and confirm. The display shows Registering and the name of the base flashes, e. g. Base 1 .
		Press lit Register key on the base for approx. 4 seconds (page 12); the key flashes. The base is only ready for registering while the key is flashing.
 INT11: Int.11	OK	Select internal number and confirm, e. g. INT11: Int.11 .



After registration the handset reverts to idle status. The handset's internal number is shown in the display, e. g. **Int.11**.

Registering a Gigaset 4000 Comfort/Micro handset

		Hold down, to turn on the handset.
either ...		
OK		Confirm the prompt.
or ...		
 Settings	OK	Select the menu item and confirm.
 Register H/Set	OK	Select the menu item and confirm.
 Base	OK	Select base (1–4) and confirm, e. g. Base 1 .
... then		
 OK		Enter the system PIN of the base (factory setting: 0000) and confirm.
		Press lit Register key on the base for approx. 4 seconds (page 12); the key flashes. The base is only ready for registering while the key is flashing.
 INT11: Int.11	OK	Select internal number and confirm, e. g. INT11: Int.11 . The successful registration is confirmed on the display.

Registering a Gigaset 4000 Classic handset

<i>i</i>	You can register a maximum of four Gigaset 4000 Classic handsets. Register Gigaset 4000 Classic handsets before other handsets.
----------	---





MENU		Open the menu.
 Register H/Set	OK	Select the menu item and confirm. PIN is displayed.
 OK		Enter the system PIN of the base (the default is 0000) and confirm.
		Press lit Register key on the base for approx. 4 seconds (page 12); the key flashes. The base is ready for registering only when the key is flashing.

Once the system PIN has been entered the handset searches for a base with this PIN. While it is searching **Register H/Set** flashes in the display. After registration the handset reverts to idle status. **Your handset is now ready for operation!**

The next unassigned internal number between **Int.11** and **Int.18** is automatically assigned to the handset as it is registered.







Getting started

Registering a Gigaset 3000 Comfort/Micro handset











	Hold down, to turn on the handset.
either ...	
YES	Confirm the prompt.
or ...	
	Open the menu.
↓ Stations OK	Select the menu item and confirm.
↓ Station 1 	Select the base (1-4) and open the sub-menu.
↓ Registration OK	Select the menu item and confirm.
... then	
 OK	Enter the system PIN of the base (factory setting: 0000) and confirm.
	Press lit Register key on the base for approx. 4 seconds (page 12); the key flashes. The base is only ready for registering while the key is flashing.
↓ INT11: Int.11 OK	Select internal number and confirm, e. g. INT11: Int.11 . The successful registration is confirmed on the display.

The next unassigned internal number between **Int.11** and **Int.18** is automatically assigned to the handset as it is registered.

Registering a Gigaset 3000 Classic handset

	Hold down, to turn on the handset.
 INT 	Press in turn.
 OK	Enter the number of the base (normally 1) and confirm. The Standby symbol  flashes and then lights up constantly when the connection to the base has been established.
 OK	Enter the system PIN of the base (factory setting: 0000) and confirm.
	Press lit Register key on the base for approx. 4 seconds (page 12); the key flashes. The base is only ready for registering while the key is flashing.
↓ INT11: Int.11 OK	Select internal number and confirm, e. g. INT11: Int.11 . The successful registration is confirmed on the display.

Registering a Gigaset 2000 C handset









		Press to turn on the handset.
		Open the menu.
 Settings	OK	Select the menu item and confirm.
 Registration	OK	Select the menu item and confirm.
 Station 1	OK	Select base (1-4) and confirm.
		Open the submenu.
 Registration	OK	Select the menu item and confirm.
 OK		Enter the system PIN of the base (factory setting: 0000) and confirm.
		Press lit Register key on the base for approx. 4 seconds (page 12); the key flashes. The base is only ready for registering while the key is flashing.
 INT11: Int.11	OK	Select internal number and confirm, e. g. INT11: Int.11 . The successful registration is confirmed on the display.

Registering a Gigaset 2000S / Gigaset 1000 C/S handset

For the registration procedure described below:

You can register a maximum of four other handsets (e. g. Gigaset 2000S, GAP handsets) or wireless devices (e. g. Gigaset 1000 TAE, STA). Register these devices first.

Registering a Gigaset 2000S handset

		Press  (off).
 		Simultaneously press the number of the base station and  (on).
 		Enter system code and press the hash key.
		Press lit Register key on the base for approx. 4 seconds (page 12); the key flashes. The base is only ready for registering while the key is flashing.

The lowest free internal number is assigned. It is not possible to select a free internal number.

Registering a Gigaset 1000 C/S handset

For the registration procedures, please refer to the corresponding operating instructions.

Getting started

De-registering handsets

Handsets are de-registered using a handset (see handset operating instructions). Example:

		Open the menu.	
↓	Base Settings	OK	Select the menu item and confirm.
↓	Settings	OK	Select the menu item and confirm.
	OK		If necessary, enter the system PIN of the base (the default is 0000) and confirm.
↓	Setup user	OK	Select the menu item and confirm.
↓	De-reg. device	OK	Select the menu item and confirm.
↓	INT16: Int.16	OK	Select the handset that you wish to de-register and confirm, e. g. INT16: Int.16 .

The other registered devices retain their previous internal numbers.

Locating a handset (paging)

If you have mislaid your handset you can page it with the help of the base. The Register/Paging key is located on the top of the base (page 12).

Paging:

Press the Register/Paging key on the base for 1 second. All handsets will ring together ("Paging").

End paging:

Press the Register/Paging key on the base for a maximum of 1 second or the Talk key on the handset.

The quick way into the world of ISDN

What is an MSN?

MSN = Multiple Subscriber Number. You can apply for up to ten different telephone numbers for one multiple ISDN connection. An MSN is one of the phone numbers assigned to you **without an area code**.

Your telephone uses the MSN entirely as you require. The following differentiation is made:

- ◆ **Receive MSN:** Phone numbers you may be called on. You can assign the receive MSN's to specific internal users (terminals). Incoming calls are only forwarded to the terminals to which the relevant receive MSN has been assigned. Terminals can be handsets or answering machines.
- ◆ **Send MSN:** Phone numbers that are assigned to the person you are calling. The network operator calculates charges based on the send MSN's. You can assign a fixed send MSN to each internal user.

Potential internal users are:

- ◆ **Handsets**, to which you can assign the internal numbers 11 to 18.
- ◆ **Data modules** (page 31), to which you can assign the internal numbers 41 to 48.
- ◆ The integrated **answering machines** (on SX255isdn), which are assigned the internal phone numbers 91 to 93.
- ◆ PC via a USB port for which the internal number 40 is provided.
- ◆ Analogue terminals, to which you can assign the internal numbers 21 or 22.

Example of how to assign an MSN:

You have applied for four MSN's, two for business use (MSN1, MSN2) and two for private purposes (MSN3, MSN4). Four handsets are connected to a base. Two handsets (Int.11 and 12) and the answering machine AM 91 are intended for business use, and two handsets (Int.13 and 14) and the answering machine AM 92 are intended for private use.

Internal users	Use	Receive MSN	Send MSN
handsets Int.11, 12	Business	MSN1, MSN2	MSN1
Answering machine AM 91		MSN1, MSN2	---
Handset Int.13	Private	MSN3	MSN3
Handset Int.14		MSN4	MSN4
Answering machine AM 92		MSN3, MSN4	---

Further information for dealing with MSNs, e. g. setting the ring delay for each MSN, can be found in the handset operating instructions.

Answering machine

Your ISDN telephone has three answering machines (AM1, AM2, AM3). Once you have connected your telephone, answering machine AM1 is shown and activated. By default, answering machines AM2 and AM3 are hidden. To use them, they must be shown and all shown answering machines must be assigned their own receive MSN. You can configure AM1, AM2 and AM3 separately.

You can operate the answering machines

- ◆ either directly using a registered handset (in the menu) or
- ◆ by remote control (internal or external call to answering machine).

Remote control is a convenient option, allowing you day-to-day use of an answering machine wherever you are. To configure the answering machines, you will need a handset that is registered on the base (see handset operating instructions).

Definitions of terms used below:

Message	Message that a caller leaves on the answering machine.
Memos	"Spoken notes" that you can record on the answering machine for members of your family or colleagues, for example.
AM mode	Recording or announcement.
Answer and record mode	The caller hears an announcement and may then leave a message.
Announce only mode	The caller hears your announcement but cannot leave a message.

i

If an answering machine is currently being used by one user (directly or by remote control), then no other user can access the answering machine during this time.

Operation using a registered handset

Which answering machine you can operate directly using your handset depends on the assignment of the receive MSNs:

No MSN is assigned to the answering machines (factory setting):

- ◆ AM1 answers all calls.
- ◆ Each answering machine can be set, operated and played back from each handset/terminal.

One or more MSNs are assigned to each answering machine:

Each answering machine can only be set and played back using handsets/terminals with the same receive MSN.

Exception: If a receive MSN is assigned exclusively to one answering machine, and not to any other handset/terminal, then this answering machine can be operated by all internal users.

Range of functions

Using a handset registered on the base, the following functions are available (see the handset operating instructions for more details):

Configuration of answering machine

- ◆ Assigning a receive MSN
- ◆ Hiding/showing an answering machine
- ◆ Specifying the number of rings before the answering machine starts
- ◆ Deactivating/activating spoken date and time
- ◆ Setting the recording time and recording quality
- ◆ Activating/deactivating automatic pause
- ◆ Locking the answering machine, defining AM PIN
- ◆ Setting time control (only using S44, S1 and SL1)
- ◆ Activating/deactivating automatic listen in on the handset
- ◆ Activating/deactivating automatic call pick up
- ◆ Activating/deactivating automatic notification via text message

Operating the answering machines

- ◆ Selecting an answering machine
- ◆ Activating/deactivating the answering machine
- ◆ Selecting announce only and AB mode
- ◆ Recording/changing announcements
- ◆ Playing back/deleting announcements
- ◆ Recording memos
- ◆ Two-way recording
- ◆ Picking up a call while the answering machine is in operation
- ◆ Playing back messages
- ◆ Returning a call during playback
- ◆ Playing a message to another caller
- ◆ Playing back memos
- ◆ Setting the playback speed (only using S44, S1 and SL1)
- ◆ Deleting messages/memos
- ◆ Marking an old message or memo as "new"
- ◆ Adding a number to the phonebook
- ◆ Checking the status of an answering machine

Remote control of answering machines

With the remote control option, you can operate your answering machine, e. g. listen to and delete messages

- ◆ from a registered handset, a connected cord telephone or
- ◆ from external telephones and handsets.

Apart from the first step, the procedure is the same for both kinds of remote control.

The following functions are available when using remote control:

- ◆ Activating/deactivating the answering machine
- ◆ Messages and memos
 - Play
 - Skip
 - Delete
- ◆ Announcement
 - Record
 - Play
 - Select
- ◆ Recording internal memos
- ◆ Help



Precondition:

- ◆ For external operation, **you must change the answering machine PIN** for your own **security** (factory setting: 0000).
- ◆ In order to be able to use the full range of functions of this mode, you must enable "Remote control" **and** "Remote delete" on the base (see handset operating instructions).

Starting remote control









Operating the answering machine while you are away from home

For remote control you need a telephone that transmits DTMF tones (tone dialling). It is important to enter the AM PIN immediately while the announcement is being played. In addition **Remote control** and, if required, **Remote delete** must be activated.



	Dial your own telephone number.
	When the announcement starts, enter the AM PIN at once.

Operating the answering machine from the handset (internal)



There is a **voice-controlled help** for the two-key functions;

 	Help with deleting
 	Help with new messages/phrases
 	Help with recording
 	Help with modes

Added-feature and standard handset



	Open list of internal users.
	Enter internal phone number for the answering machine: 91 or 92 or 93.
	Enter AM PIN if required.

Handset made by another manufacturer (GAP mode)

	Lift the receiver. If necessary, press another key to initiate an internal call.
	Enter internal phone number for the answering machine: 91 or 92 or 93.
	Enter AM PIN if required.



Cordless phone adapter and normal telephone

<i>i</i>	Automatic line seizure must be deactivated (see handset operating instructions). As supplied, automatic line seizure is activated!
----------	--

	Lift the receiver.
	Enter internal phone number for the answering machine: 91 or 92 or 93.
	Enter AM PIN if required.

Key sequences for remote control

Once you have initiated remote control of the answering machine, the functions of the keys are the same for all telephones.

		
1	2	3
	Pause/Stop	Record
4	5	6
Announcement	On/Off	Operating mode
7	8	9
New	Delete	Status/Help
*	0	#

Answering machine

Activating/deactivating the answering machine	
Activate/deactivate	8
Playing back messages and memos	
All messages	2
New messages only	* 2
Pause/Stop	5
Continue playback	2
End playback	5 5
Skipping messages and memos	
To start of message	1
To previous message	1 1
To next message	3
Deleting messages and memos	
Single message during playback	0 2
All messages after playback	0 2
Recording an announcement	
Announcement 1	6 7 1
Announcement 2	6 7 2
Announcement	6 7 3
Concluding announcement	6 7 4
Playing back an announcement	
Announcement 1	7 1
Announcement 2	7 2
Announcement	7 3
Concluding announcement	7 4

Selecting an announcement	
Announcement 1	9 1
Announcement 2	9 2
Announcement	9 3
Concluding announcement	9 4
Recording internal memos	
Begin recording	6 2
End recording	5
Help	
Check settings	#
Check one-key functions	# #
Check two-key functions	see page 22
End check	5

Connecting devices

Connecting cord-based analogue devices

The internal phone numbers **Int.21/Int.22** are pre-assigned to the TAE connections. Devices connected to them must

- ◆ not be registered on the base.
- ◆ be set to tone (DTMF) dialling (pulse dialling not supported).

In addition, the corresponding device type must be set and device-specific additional settings made.

No costs are displayed on the connected devices. However, accumulated costs are recorded on the base and can be checked using an added-feature handset or on a PC.

Device types

The following settings are possible (Defining the device type, see Page 30).

- ◆ **Telephone** see Page 26, Connecting telephones
- ◆ **Fax** see Page 27, Connecting a fax machine
- ◆ **Modem** see Page 27, Connecting a modem
- ◆ **Answering mach.** see Page 27, Connecting an answering machine
- ◆ **Neutral** see Page 27, Connecting a fax machine
- ◆ **Door type1** see Page 32, Connecting door type 1
- ◆ **Doortype2(DTMF)** see Page 33, Connecting door type 2
- ◆ **No function** see Page 28, No device connected

i

Note the explanations below for the device types and their additional device-specific settings.

Connecting telephones

By default, the two TAE connections are set to **Telephone**.

This means that the base is ready to use with a telephone (with tone dialling/DTMF) connected to **Int.21** or **Int.22** even without a handset.

If you also want to use this telephone to make internal calls, automatic line seizure for the associated TAE connection must be deactivated. For external connections, it is then necessary to dial a zero first.

Information on making calls using devices on the TAE connection can be found in the handset operating instructions.

Connecting a fax machine

To operate a fax machine or a combination device (e. g. fax with telephone), the device type setting should be changed to **Fax** or **Neutral**.

For problem-free fax operation regardless of the settings of the remote terminal, the device type setting **Neutral** is recommended (with the **Fax** setting, a successful fax connection depends on the settings of the remote terminal).

If you only want to make external connections, automatic line seizure for the associated TAE connection must remain activated. In this case, the fax machine or combination device should be set to "Operate on main connection".

If, on the other hand, you also want to make internal connections, automatic line seizure for the associated TAE connection must be deactivated. For external connections, it is then necessary to either dial a zero before each number or set the fax machine or combination device to "Operation on PABX" (see fax machine or combination device operating instructions).

Use the opportunity to assign the fax a separate phone number (MSN). Assign the corresponding TAE connection an exclusive receive MSN (see handset operating instructions).

In the device type setting **Fax**, **Call waiting** and **Hunt group** are not supported.

In the device type setting **Neutral**, **Call waiting** is not supported. When connecting a fax only device, **Hunt group** should be deactivated (see handset operating instructions).

Connecting a modem

To operate a modem, the device type setting must be changed to **Modem**.

If you only want to make external connections, automatic line seizure for the associated TAE connection must remain activated (see handset operating instructions). In this case, the modem should be set to "Operate on main connection".

If, on the other hand, you also want to make internal connections, automatic line seizure for the associated TAE connection must be deactivated. For external connections, it is then necessary to either dial a zero before each number or set the modem to "Operation on PABX" (see modem operating instructions).

Connecting an answering machine

If you want to operate an answering machine (or a telephone with integrated answering machine) on the TAE connection, the device type setting **Answering mach.** is recommended. In this setting, the answering machine can pick up a call.

If a telephone with integrated answering machine is connected and you want to use this telephone to make internal calls, automatic line seizure for the associated TAE connection must be deactivated (see handset operating instructions). For external calls, it is then necessary to dial a zero first.

In the device type setting **Answering mach.**, **Call waiting** and **Hunt group** are not supported (see handset operating instructions).

Connecting devices

"Neutral" setting

This setting is suitable for telephone, fax and modem operation. For problem-free fax operation regardless of the settings on the partner station, the device type setting **Neutral** is recommended (page 27).

Call waiting is not supported in the device type setting **Neutral**.

Adding a wait melody from an external device

This device type setting is a requirement for adding the wait melody from an external device. The option **External** is only available for setting up the wait melody if an analogue connection has been configured as **Ext. music/hold** (page 27).

Setting up the wait melody

An external subscriber hears the set wait melody if the connection is on hold in the base station (internal). An external subscriber whose connection is on hold in the telephone exchange (external) and an internal subscriber who is on hold will not hear a wait melody.

The following settings can be chosen:

Internal	The subscriber on hold hears the base station wait melody.
External	The wait melody is added from an external device. For this the analogue connection must be configured as Ext. music/hold . If the analogue connection is configured differently the External setting is not offered. Please comply with any legal regulations.
Off	If the wait melody is deactivated, no setting can be made.

By default, **Internal** is activated.

You must make these settings on the handset. Further information about this will be found in the operating instructions for your handset.

No device connected

For each TAE connection, to which no device is connected, the device type must be set to **No function**, in order to prevent malfunctioning of the **Reject all** (see handset operating instructions) and **Busy on busy** (see handset operating instructions) ISDN functions.

Making calls with devices on the analogue connection (TAE connection)

Telephones with tone dialling (DTMF = dual tone multi-frequency dialling) can be operated on the analogue connections. Telephones with pulse dialling are not supported.

Automatic line seizure

With automatic line seizure activated, the external line is seized as soon as the receiver is lifted. As a consequence, normal internal dialling is no longer possible. However, an internal call is still possible by way of an internal enquiry using the **(R)** key. You can activate automatic line seizure with any added-feature handset (see added-feature handset operating instructions).

Making external calls

Auto. line seizure inactive

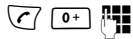

Auto. line seizure active



Making internal calls

Auto. line seizure inactive



Group call to all internal users

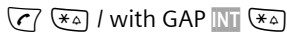

Auto. line seizure inactive



Call waiting

You hear the call waiting tone during your external call.

either ...

 Call disconnected, wait for ring 

or ...



(R) Caller 1 on hold.

Switch to waiting caller – Toggling

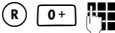

(R)	Caller 1 on hold.
(R)	Caller 2 on hold etc.

Connecting devices





Making an external enquiry

	
	Switch between callers if necessary.

Making an internal enquiry

	Making an internal enquiry
	Switch between the callers if necessary.

Transfer call before/after answer

either ...	Transfer before answer:
	
	Hold down (return to idle status).
or ...	Transfer after answer:
	Transfer call after answer. Making an enquiry call.
	Hold down (return to idle status).

Picking up a call while the answering machine is in operation

You can pick up a call, even if the answering machine has already switched itself on on the second analogue connection, your announcement is running, or the caller is already leaving a message. When you pick up the call the recording stops.

You can deactivate automatic call pick up (see handset operating instructions) and carry on an existing call, while the answering machine is switched on.

Automatic line seizure must be deactivated (page 29).

Automatic call pick up (factory setting) Automatic call pick up inactive

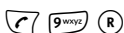

i	The requirement for call pick up is that the answering machine and the internal user picking up the call are assigned the same receive MSN (page 19) and the device type Answering mach. is set for the internal number of the answering machine (page 27).
----------	--

Defining the device type

You must define the device type on the handset or PC. You can find more information in the operating instructions for your handset or PC software.

Connecting PC via USB

You can connect a PC with a cable using the USB port on your base and connect one or more PCs without a cable using the Gigaset M10x data modules.

Your base then offers you the option of using a connected PC to:

- ◆ Configure your base
- ◆ Manage phonebooks from the PC, base and handsets.

Using a PC connected with a cable or via a Gigaset M101 Data, you can also fax from the PC (using fax emulation with no hardware requirements).

In conjunction with the enclosed software (talk&surf 6.0) this offers you the option of

- ◆ using data transmission and the Internet from the PC using the ISDN network access on your base (e. g. surfing the Internet, e-mail, home banking).
- ◆ Transmit data between different PCs.



You can find further information in the instructions for the software (talk&surf 6.0).

Wireless PC connection: Gigaset M101 Data and Gigaset USB-Adapter DECT/M105 data modules

The Gigaset M101 Data with V24 interface and the Gigaset DECT/M105 USB Adapter with USB interface give you the option of establishing a wireless connection between your PC and the base. A connection via a Gigaset M10x Data data module provides you with a 64 kbit/sec. interface.

The internal phone numbers **PC 41** to **PC 48** are set aside for this purpose on your base. For installation, see the installation instructions on the CD-ROM enclosed with the data module.

Wire-based PC connection: Base USB port

You can establish a wire-based connection to a PC using the USB port on your base (page 8). The internal phone number **PC 40** is set aside for this purpose on your base.

1. Plug the USB cable into the base only first of all (do **not connect it with the PC immediately**).
2. Only connect the USB cable to the PC when prompted to do so by the PC program **talk&surf 6.0**.

A wire-based connection via the USB port on the base provides you with a 128 kbit/sec. interface.

Gigaset Repeater

You can increase the range of your handsets with the Gigaset Repeater. Your telephone is set up to use a Gigaset Repeater (accessory). To ensure the Repeater is installed correctly, Repeater mode must be activated on the base (see handset operating instructions).

Operation of entrance telephone

For details of setting up an entrance telephone, refer to the handset operating instructions.

Connecting entrance telephones

In case of questions about the entrance telephones shown here or any other systems, please contact the respective manufacturers or suppliers.

We ask for your understanding that Siemens AG cannot provide any guarantee of the currency, completeness and accuracy of the circuit diagrams.

Several examples are illustrated below. Current circuit diagrams are available from your retailer.

Door type 1

The following examples provide guidance for connecting entrance telephones using a TFE adapter (door type 1).

Siedle TLM 512/612, TLE 061, CTB 711

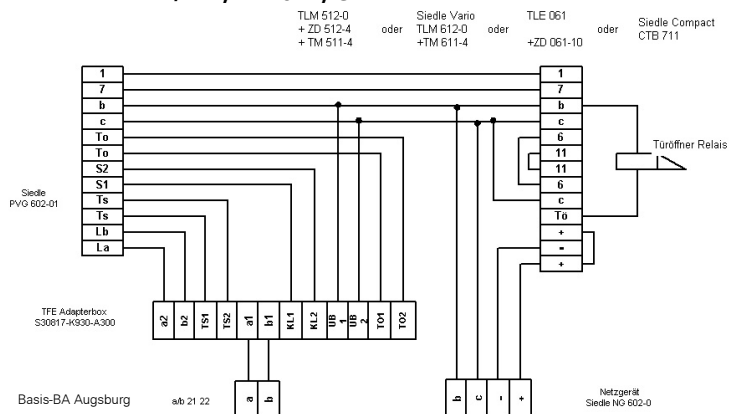

Ritto entrance telephone and door opening system



! **Caution!**
Connect base power unit 6573 and additional unit TFV5680 using enclosed bus connector.

Ritto TwinBus entrance system

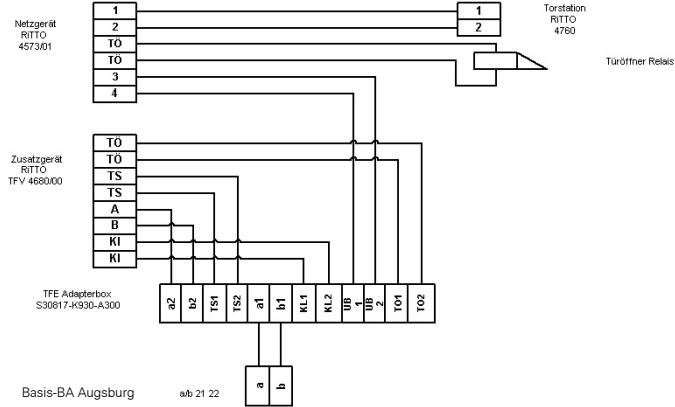

! **Caution!**
Connect base power unit 4753/01 and additional unit TFV4680/00 using enclosed bus connector.

Door type 2 (DTMF)

For details of connecting entrance telephones with DTMF control (door type 2), refer to the example below.

Deutsche Telekom DoorLine

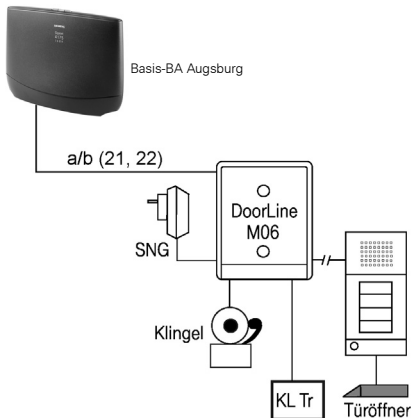

Appendix

Care

Wipe the base and handset with a **damp** cloth (no solvents) or an antistatic cloth. **Never** use a dry cloth. This can cause static discharge.

Contact with liquid

If the handset should come into contact with liquid, **on no account switch the device on. Remove all batteries immediately.**

Allow the liquid to drain out of the device, and then pat all parts of the device dry.

Keep the handset with the batteries removed in a warm, dry place for at least 72 hours. In many cases, you will then be able to use it again.

Questions and Answers

If you have any questions about the use of your phone, you can contact us 24 hours a day at www.siemens.com/customercare. You will find the most frequently asked questions and the corresponding answers below.

What has happened if ...	Possible Cause	Possible solution
... the handset or the base does not ring?	The ringer is switched off. Call forwarding is set to Immediately . Night service is active.	Activate the ringer for the handset or the base. Switch off call forwarding. Deactivate night service. (see handset operating instructions)
... the answering machine says "PIN is incorrect" during remote control?	The system PIN entered is incorrect or still set to 0000.	Enter the system PIN again or set a PIN that is different from 0000 (see handset operating instructions).
... the answering machine does not record any messages or has automatically switched over to 'announce only'?	Its memory is full.	Delete old messages Play back new messages and delete. (see handset operating instructions)
... there are no incoming calls ?	"Constant" call forwarding is activated. The MSN has not been assigned to the internal user. The "internal" authorisation is set.	Deactivate "Constant" call forwarding. Determine the receive MSN. Change the authorisation. (see handset operating instructions)
... the telephone also rings for fax-PC calls?	The phone number is in the phone number list on the base.	Delete the corresponding phone number (MSN) in the list. (see handset operating instructions)

What has happened if ...	Possible Cause	Possible solution
... you have a PABX and, after dialling, the wrong connection or no connection is made?	You have entered the wrong prefix.	Check and correct the prefix (see handset operating instructions).
... some of the ISDN functions do not work as stated?	The ISDN function has not been enabled.	Check with your network provider.
... another telephone on the So bus does not ring ?	The same MSN was assigned to the telephones. One of the telephones also has internal call divert activated.	Switch off the internal call divert or set external call divert. (see handset operating instructions).

Service (Customer Care)

You can get assistance easily when you have technical questions or questions about how to use your device by using our online support service on the Internet at:

www.siemens.com/customer-care

or by referring to the section entitled **Questions and answers** in this manual (page 34).

Appendix

If the device needs to be repaired, please contact one of our Customer Care Centers:

Abu Dhabi	0 26 42 38 00	Luxembourg	43 84 33 99
Argentina	0 80 08 88 98 78	Macedonia	02 13 14 84
Australia	13 00 66 53 66	Malaysia	03 21 63 11 18
Austria	05 17 07 50 04	Malta	00 35 32 14 94 06 32
Bahrain	40 42 34	Mauritius	2 11 62 13
Bangladesh	0 17 52 74 47	Mexico	01 80 07 11 00 03
Belgium	0 78 15 22 21	Morocco	22 66 92 09
Bosnia Herzegovina	0 33 27 66 49	Netherlands	0900-3333102
Brazil	0 80 07 07 12 48	New Zealand	08 00 27 43 63
Brunei	02 43 08 01	Norway	22 70 84 00
Bulgaria	02 73 94 88	Oman	79 10 12
Cambodia	12 80 05 00	Pakistan	02 15 66 22 00
Canada	1 88 87 77 02 11	Philippines	0 27 57 11 18
China	0 21 50 31 81 49	Poland	08 01 30 00 30
Croatia	0 16 10 53 81	Portugal	8 00 85 32 04
Czech Republic	02 33 03 27 27	Qatar	04 32 20 10
Denmark	35 25 86 00	Romania	02 12 04 60 00
Dubai	0 43 96 64 33	Russia	(800) 200 10 10
Egypt	0 23 33 41 11	Saudi Arabia	0 22 26 00 43
Estonia	06 30 47 97	Serbia	01 13 22 84 85
Finland	09 22 94 37 00	Singapore	62 27 11 18
France	01 56 38 42 00	Slovak Republic	02 59 68 22 66
Germany	01805 333 222	Slovenia	0 14 74 63 36
Greece	0 80 11 11 11 16	South Africa	08 60 10 11 57
Hong Kong	28 61 11 18	Spain	9 02 11 50 61
Hungary	06 14 71 24 44	Sweden	0 87 50 99 11
Iceland	5 11 30 00	Switzerland	08 48 21 20 00
India	01 13 73 85 89 - 98	Taiwan	02 25 18 65 04
Indonesia	0 21 46 82 60 81	Thailand	0 22 68 11 18
Ireland	18 50 77 72 77	Tunisia	0 71 86 19 02
Italy	02 66 76 44 00	Turkey	0 21 65 79 71 00
Ivory Coast	80 00 03 33	Ukraine	8 80 05 01 00 00
Jordan	0 64 39 86 42	United Arab Emirates	0 43 66 03 86
Kenya	2 72 37 17	United Kingdom	0 87 05 33 44 11
Kuwait	2 45 41 78	USA	1 88 87 77 02 11
Latvia	7 50 11 14	Vietnam	45 63 22 44
Lebanon	01 44 30 43		
Libya	02 13 50 28 82		
Lithuania	8 22 74 20 10		

In some countries repair and replace services are impossible where the products are not sold through our authorised dealers.

Your Gigaset is designed for operation in your country, as indicated on the packaging and on the device itself. Country-specific conditions have been taken into account. If you have any questions about the differences between the public phone networks, please contact your specialist dealer or network provider.

Authorisation

Your Gigaset is intended for operation in the countries indicated on the underside of the product and on the packaging. Country-specific conditions have been taken into account. The CE mark certifies conformity of the device with the essential requirements of the R&TTE directive.

Excerpt from the original declaration

"We, Siemens AG, declare, that the above mentioned product is manufactured according to our Full Quality Assurance System certified by CETECOM ICT Services GmbH with ANNEX V of the R&TTE Directive 99/5/EC. The presumption of conformity with the essential requirements regarding Council Directive 99/5/EC is ensured."

Senior Approvals Manager

The Declaration of Conformity (DoC) has been signed. In case of need a copy of the original DoC can be made available via the company hotline.

CE 0682

Specifications

DECT standard	supported
GAP standard	supported
No. of channels	120 duplex channels
Radio frequency range	1880 MHz to 1900 MHz
Duplex method	Time multiplex, 10 ms frame length
Channel grid	1728 kHz
Bit rate	1152 kbit/s
Modulation	GFSK
Language code	32 kbit/s (ADPCM)
Transmission power	10 mW, average power per channel
Range	up to 300 m in the open air
	up to 50 m in buildings
Power supply	220/230 V ~/50 Hz (power unit SNG 8-a)
Power consumption	In standby mode approx. 4.6W
	In call mode:
	with handset approx. 4.6W with telephone (TAE) approx. 5.2 W
Environmental conditions for operation	+5 °C to +45 °C
	20 % to 75 % humidity
ISDN connection	Euro-ISDN-Multiple Connection IAE
TAE socket (INT 21/22)	Jack: TAE 6, F/N coding
	Dialling mode: DTMF (tone dialling) Data transmission rate: max. 28.8 kbit/s
Base dimensions	approx. 152 x 213 x 61 mm (H x W x D)
Base weight	0.350 kg
Length of cables	Power supply cord approx. 3 m
	ISDN connection cable approx. 3 m
	USB cable approx. 3 m

Accessories

Gigaset S44 Handset

- ◆ Illuminated colour display (4096 colours)
- ◆ Graphic main menu with icons
- ◆ Illuminated keypad
- ◆ Handsfree
- ◆ Polyphonic ringer melodies
- ◆ Phonebook for around 200 entries
- ◆ SMS (CLIP must be enabled)
- ◆ Voice dialling
- ◆ PC interface for managing phonebook entries
- ◆ Headphone socket

www.siemens.com/qigaset44



Gigaset SL1 Handset

- ◆ Large illuminated graphic display with date and time
- ◆ Illuminated keypad
- ◆ Phonebook for around 200 entries
- ◆ Full duplex grade handsfree
- ◆ SMS
- ◆ EATONI predictive text
- ◆ Caller-specific ringer melody setting (for VIP calls)
- ◆ Download options for obtaining melodies via SMS
- ◆ Room monitor
- ◆ Walky-Talky
- ◆ Voice dialling for 29 names
- ◆ Announce name when calling
- ◆ Vibration alarm
- ◆ Connector jack for headset, PC and MP3 player



Gigaset C34 Handset

- ◆ Illuminated graphic display
- ◆ Polyphonic ringer melodies
- ◆ Handsfree operation
- ◆ Phonebook for around 100 entries
- ◆ SMS (CLIP must be enabled)
- ◆ Room monitor
- ◆ Timer

www.siemens.com/gigasetc34



Gigaset C32/C2 Handset

- ◆ Graphic display with date and time
- ◆ Phonebook for around 100 entries
- ◆ Handsfree
- ◆ SMS
- ◆ EATONI predictive text
- ◆ Caller-specific ringer melody setting (for VIP calls)
- ◆ Room monitor
- ◆ Walky-Talky

Gigaset repeater

You can use the Gigaset repeater to increase the receiving range between your Gigaset handset and the base station.





Gigaset M34 USB Data Adapter

You can use the Gigaset M34 USB to set up a wireless connection between your PC and your Gigaset. It allows you to

- ◆ surf the Internet cordlessly on your PC,
- ◆ configure your Gigaset conveniently via your PC,
- ◆ manage handset phonebooks,
- ◆ manage calls lists (log),
- ◆ use the dialler blocker to protect against unwanted chargeable connections.

www.siemens.com/gigasetm34usb

The following accessories may be plugged into the handset:

Mobile handsfree set with P2T key

With the mobile handsfree set you can make a call while keeping your hands free.



Data Cable DCA-500

For connecting your handset to the serial RS232 interface of your computer.

Data Cable USB DCA-510

For connecting your handset to the USB interface of your computer.

All accessories and batteries are available from your mobile phone retailer. Or you can order direct online from the Online Shop: www.siemens.com/shop.

The Online Shop also has the latest product information.



Only use original accessories. This will avoid possible health risks and damage, and also ensure that all the relevant regulations are complied with.

ISDN glossary

A

Added-feature connection

ISDN connection that offers three more services than the standard connection: Call forwarding, transfer of charges after the connection, and a T-mailbox.

AOC-D

Advice of Charge: During the Call. Transfers the charge information during the connection.

AOC-E

Advice of Charge: at the End of the Call. Transfers the charge information at the end of the connection.

Authorisation class

Defines which connections are permitted on a PABX terminal, e. g., internal only, incoming only, or unlimited call authorisation.

Authorisation for direct outward dialling

Different users may be assigned different levels of authorisation on a base station. For example, while User A may only take incoming calls, User B may make calls without restriction.

Automatic callback

See "Callback when the number is busy"

Automatic redial

Several attempts to call are made automatically when the line is busy.

B

Block dialling

Also pre-dialling. You may only dial or, if required, correct the phone number. Then you should lift the receiver or press the loudspeaker key.

C

Call divert

CF, Call forwarding. You want to forward calls to another number permanently. You can divert calls externally via the exchange or internally in the device itself. Call divert can be set up individually for each separate phone number (MSN) (to your mobile phone when on holiday, to the office, to a neighbour etc.).

This is carried out at the network provider's local exchange. This means the call never reaches the original destination.

There are three kinds of call divert: immediate (CFU, Call Forwarding Unconditional), when the line is busy (CFB, Call Forwarding Busy), and when the call is not answered (CFNR, Call Forwarding No Reply).

Call divert (via second B channel) / internal call divert

While external call divert takes place in the local telephone exchange of the network provider, internal call divert is implemented by your telephone. Your telephone forwards the call via the second line of your ISDN connection. This means **both phone lines are engaged for the duration of the call**. You pay the charges for the connection to the forwarding number. However, you save yourself the network provider's charges for this function.

Call forwarding during the call phase

CD, Call Deflection. Must be explicitly enabled by the network provider for each ISDN connection. CD enables an incoming call to be forwarded to any phone number while it is ringing, without having to answer the call. Because the caller cannot affect on where it is forwarded (for example, to a mobile phone), you will pay the resulting charges. The caller must only pay the normal telephone charges to the connection he dialled.

Call transfer (e. g., for ISDN PABX's)

ECT, Explicit Call Transfer. User A calls User B. He puts the connection on hold and calls User C. Rather than connect everyone in a three-party conference, A now transfers User B to C and hangs up.

Call waiting

CW, Call Waiting. Service provided by the network provider. An acoustic signal during a call indicates that another caller is waiting. In addition, ISDN phones indicate this with a displayed message. You can then decide whether to accept or reject the second call.

Call waiting protection

Deactivates the call waiting signal.

Callback when the call is not answered

If a user does not respond when called, a caller can arrange an automatic callback. As soon as the destination phone has completed a call and is free again the caller is rung back. This service must be supported by the exchange. The ringback request is automatically cancelled after approximately 2 hours (depending on the telephone exchange).

Callback when the number is busy

Callback must first be activated on the caller's terminal. A connection is established automatically as soon as the destination phone is no longer busy. As soon as the connection is free the caller is rung back. As soon as the caller lifts his receiver the connection is made automatically.

Caller identification

Displays caller's phone number, name or type of connection (e. g., exchange/internal) on the telephone screen.

Caller list

Depending on the setting, the calls list contains callers you haven't reached, or those you have spoken to. The last 20 missed calls and the last 20 accepted calls are stored with their phone number, date and time. If you wish to do so, you can return the call to these users directly from this list.

Capture

Performance feature "Identify/capture". MCID stands for "Malicious Call Identification". If you receive annoying calls, you can have the telephone exchange store the caller number. This performance feature must be requested from the network provider.

CCBS (Completion of Calls to Busy Subscriber)

See "Callback when the number is busy"

CCNR (Completion of Calls No Reply)

See "Callback when the call is not answered"

CD (Call Deflection)

See "Call forwarding during the call phase"

CF (Call forwarding)

See "Call divert"

Channel

Like an analogue connection, an ISDN connection enters the building through two cables, but for ISDN a distinction is made between the two bearer channels called the B-channels (which have nothing to do with the physical cables!) and the control channel, otherwise known as the D channel.

Charge detail display

See "AOC-D" and "AOC-E"

CLI (Calling Line Identification)

The caller's phone number is transmitted.

CLIP (Calling Line Identification Presentation)

User A calls User B. A's phone number appears on B's telephone display.

CLIR (Calling Line Identification Restriction)

Stops your personal phone number being displayed.

CNIP (Calling Name Identification Presentation)

User A calls User B. A's name appears on B's telephone screen.

COLP (Connected Line Identification Presentation)

User A calls User B. B's phone number is displayed on A's telephone. If B has programmed call forwarding to C: then the dialled number and transferred number are not identical, and the phone number of C is displayed if C permits his phone number to be displayed.

COLR (Connected Line Identification Restriction)

If C has set up COLR, then C's phone number is not displayed on A's phone.

Conference call

See "Three-party conference"

CW (Call Waiting)

See "Call waiting"

D

D channel

Control channel for an ISDN connection. See "Channel"

Digital exchange

Computer controlled switching units allow quick connection and the activation of such additional services as => enquiry calls, => call waiting, => three-way conference, => call forwarding etc.

Direct call

Block the telephone for all phone numbers except for an individually entered number. After picking up the handset and pressing any key, the connection to the saved phone number is established. Ideal for children who cannot yet dial phone numbers (baby call). Calling an emergency number is always possible. This function is available on the Gigaset 3000/2000 Comfort handsets.

E

ECT (Explicit Call Transfer)

See "Call transfer"

Electronic code lock

Personal code (=> PIN), used, for example, to protect a phone against unauthorised use – only calls to emergency numbers may still be made. Incoming calls may be accepted.

Enquiry calls

You are making a call. Using the "Enquiry call" function, you interrupt the conversation briefly to establish a second internal or external connection to another user. If you terminate the connection to this user immediately, then this was an enquiry call. If you switch to and fro between the first and second user, it is called toggling.

Exchange

Nodal point in the public telephone network. A distinction is made, for example, between local exchanges and long-distance or trunk exchanges.

H

Handsfree

A phone's handsfree set not only permits open listening but also allows you to talk to the person on the other end without lifting the receiver by means of an integrated microphone. This means others present in the room can also participate in the conversation.

Hold

(Hold the line). Interrupts and re-instates an existing connection. In particular, it permits enquiry calls and toggling between calls.

I

Internal calls

Connection between the base station and handsets made free of charge.

Internal ringer

Special ringtone on PABX's to distinguish between internal and external calls.

ISDN

Abbreviation for Integrated Services Digital Network, i.e., a digital network for integrating services. This includes the integration of telephone, fax or data transmission.

ISDN abbreviations

CW	Call waiting
CF	Call divert
3PTY	Three-party conference
CCBS	Callback when the number is busy
CD	Call forwarding during the call phase

K

Keypad

The keypad supports special function keys such as the star (*) and hash (#) keys. In this way, special functions offered by your network provider can be initiated using a code, such as "#4711*".

M

MCID (Malicious call identification)

See "Capture"

MSN

Multiple Subscriber Number. The phone numbers belonging to a multiple ISDN connection. Each terminal is addressed separately, e. g., a separate number for a fax machine. There are three MSN in the basic price for the standard and comfort connection. Up to ten MSN can be assigned to one ISDN connection.

Multiple connection

ISDN connection that has up to ten MSN available, in contrast to the system connection with one call director number block. This is the preferred type of ISDN connection for private customers.

Multiple subscriber number

See "MSN"

Music on hold

See "Wait melody"

Mute

Convenience feature for telephones, which deactivates the built-in microphone (in handset or handsfree unit).

N

Notebook function

During a phone call you can enter a phone number in the phone's temporary memory to be dialled later.

NT/NTBA

Network terminating device (NT = Network Terminator and NTBA = Network Terminator Basic Access). The public T-ISDN is terminated with an NT. The NT acts as a bridge to the existing telephone outlet. Only the NT can or may be connected to the telephone outlet. Under no circumstances should analogue terminals also be connected to the phone outlet. ISDN terminals and additional ISDN outlets are connected to the NT.

O

Open listening

At the touch of a key, all those present in a room can listen in to a phone call via an integrated loudspeaker. See also "Handsfree talking".

Outgoing MSN, freely selectable

A feature which helps you to individually determine which MSN should be used for the following call. This is not only important for the phone number display on the called handset but also for billing charges. This is because call charges, which can be broken down free of charge according to MSN on the network provider invoice, are billed according to the MSN used to make the call.

P

Parking

A call is parked when you want to unplug the telephone during a call, or you want to continue your call from another telephone with the same connection. The connection is retained while it is parked.

Phonebook

An added feature on a phone allowing the name and phone number of several users to be stored. The phone numbers can quickly be found and dialled.

PIN

Abbreviation for Personal Identification Number. Protects against unauthorised use, e. g., system PIN, answering machine PIN, handset PIN.

Plugging to bus

TP, Terminal Portability. Also called parking. An incoming call can be held at the local exchange for up to three minutes to then be accepted, for example, by another phone, a fax machine or a PC. In the meanwhile the caller hears an appropriate announcement.

Pre-dialling, see also "Block dialling"

For some telephones with a display you can enter the phone number first, and check it once more before dialling.

R

Remote activation

Allows the answering machine to be activated and deactivated during a call. This function is PIN-protected.

Remote check

Answering machine function. Listen to messages remotely, mostly together with options like delete messages or change announcements.

Repeater

A repeater increases the range of a handset connected to a base station. The device receives the radio signal from the base station and broadcasts it further.

Ring delay

For each internal party, you can specify how many rings take place before this party hears the ring. This can also be set for each MSN phone number.

For example, your handset, in addition to the base telephone (which rings on the first ring) could ring after three rings for the private phone number, and ring on the first ring for the business phone number.

S

S0 Bus

Four-wire ISDN connection wiring. It provides two B-channels and one D-channel. Up to twelve ISDN outlets can be connected to it, on which up to eight terminals can be operated at the same time.

Standard connection

ISDN connection with a series of services such as call waiting, three-party conference, or callback when the number is busy. See also "Comfort connection".

T

Three-party conference

3PTY, three-party. Interconnection with two external users (ISDN or analogue network customers).

Toggling

Toggling allows you to switch between two external callers without allowing the waiting caller to listen in.

TP

Terminal Portability, see "Plugging to bus".

Two-way recording of phone calls

Answering machine feature which allows you to record a conversation during a phone call.

W

Wait melody

Music on hold. During an enquiry call or when a call is being transferred, a melody is played which the waiting person can hear.

Withhold own number (CLIR)

Stops your personal phone number being transferred.

Index

A

- Accessories 38
- Added-feature connection 41
- Analogue
 - Making calls with analogue devices 29
- Announce only (answering machine). 20
- Announcement (answering machine)
 - Note 20
- Announcement (answering machine) 20
- Answer and record (answering machine) 20
- Answering machine 20
 - Announcement 20
 - Connecting 27
 - Key sequences for remote control. . 23
 - Memos 20
 - Messages 20
 - Operating from handset. 22
 - PIN 22
 - Remote control 22
 - Remote delete 22
- AOC-D 41
- AOC-E. 41
- Authorisation class 41
- Authorisation for direct outward dialling 41
- Automatic callback 41
- Automatic redial 41

B

- Base
 - As desktop unit 6
 - Connecting 7
 - Installation 4
 - Installation (notes). 5
 - Installation location 5
 - Preparing for use 5
 - Setting 9
 - Wall mounting. 6
- Base station
 - Overview. 1
- Block dialling 41

C

- Cable
 - ISDN connection cable 7
 - Power supply cord 7
 - USB cable. 31
- Call divert 41, 42
- Call waiting 42
- Call waiting protection 42
- Callback
 - When the call is not answered. . . . 42
 - When the number is busy 42
- Caller identification 42
- Caller list 42
- Care of the telephone 34
- Catching a nuisance caller 43
- CF. 43
- CF, see also Call divert
- Channel 43
- Charge detail display 43
- CLI 43
- CLIP. 43
- CLIR 43, 48
- CNIP 43
- COLP 43
- COLR 43
- Conference call 43
- Connecting
 - Answering machine 27
 - Auxiliary equipment 8
 - Base. 7
 - Devices 26
 - Fax machine. 27
 - Modem 27
 - Telephone 26
- Connecting a fax machine 27
- Connecting a modem. 27
- Connecting auxiliary equipment. 8
- Connection
 - TAE 26
- Connector
 - Mini-Western 7, 8
 - TAE 7, 8
- Contact with liquid. 34
- Customer Care (Service). 35
- Customer service 35
- CW, see Call waiting

Index

- D
 - D channel 44
 - Data modules 31
 - Defining the device type 30
 - De-registering a handset 18
 - Desktop unit (base) 6
 - Device type
 - Defining 30
 - Setting 26
 - Devices
 - Connecting 26
 - Making calls with analogue devices 29
 - Medical 4
 - Digital exchange 44
 - Direct call 44
- E
 - ECT. 44
 - Electronic code lock. 44
 - Enquiry calls 44
 - Entrance telephone 32
 - Exchange 44
- G
 - Getting started 5
 - Getting started wizard 9
 - Gigaset
 - M101 Data 31
 - Repeater 31
 - USB Adapter DECT/M105 31
- H
 - Handset
 - De-registering 18
 - Paging 18
 - Registering 12
 - Handsfree 44
- I
 - Installation
 - Base (mounting) 6
 - Base (notes). 4, 5
 - Installation location (base). 5
 - Internal
 - Calls 45
 - Numbers 19
 - Ringer 45
- Users 19
- ISDN 45
 - Abbreviations 45
 - Connection cable 7
 - Phone number, see MSN
 - Telephone connection. 5
- K
 - Key
 - Paging 18
 - Keypad 45
- L
 - Listening in on a call. 46
- M
 - M101 Data. 31
 - Mains outlet. 5
 - MCID. 45
 - Medical appliances. 4
 - Memos, see Answering machine
 - Messages, see Answering machine
 - Mini-Western connector 7, 8
 - Mounting the base on a wall. 6
 - MSN 19, 45
 - Multiple connection 45
 - Multiple subscriber number, see MSN
 - Music on hold 45
 - Muting the telephone. 45
- N
 - Notebook function 46
 - Notes (spoken), see Memo
 - NTBA. 7, 46
- O
 - Outgoing MSN, freely selectable 46
- P
 - Pack contents. 5
 - Paging key 18
 - Parking a call 46
 - Phonebook 46
 - PIN 9, 10, 46
 - Plugging to bus 46
 - Power failure 7
 - Power supply cord 7
 - Power supply unit 4, 7

- Pre-dialling 41, 46
- Putting a connection on hold 44

- Q**
- Questions and Answers 34

- R**
- Radio reception 5
- Range 5, 31
- Registering a handset 12
- Remote activation 47
- Remote check 47
- Remote delete, see Answering machine
- Repeater 31, 47
- Ring delay 47

- S**
- SO**
- Bus 47
- Jack 7
- Safety precautions 4
- Service 35
- Setting
- Base 9
- Device type 26
- Setting up a wait melody 28
- Socket
- TAE 37
- Specifications 37
- Standard connection 47

- T**
- TAE 7, 8
- Connection 26
- Socket 37
- Telephone
- Care 34
- Connecting 26
- Three-party conference 47
- Toggling 47
- TP 47
- Transferring a call 42
- Two-way recording of phone calls . . . 47

- U**
- USB Adapter DECT/M105 31
- USB cable 31

- W**
- Wait melody 48
- Adding from an external device . . . 28
- Setting up 28
- Wall holder 5